

MSI

MICRO-STAR INTERNATIONAL

MS-6368 Micro-ATX Mainboard



Version 5.0
G52-MA00463

Manual Rev: 5.0
Release Date: October 2001



FCC-B Radio Frequency Interference Statement

This equipment has been tested and found to comply with the limits for a class B digital device, pursuant to part 15 of the FCC rules. These limits are designed to provide reasonable protection against harmful interference when the equipment is operated in a commercial environment. This equipment generates, uses and can radiate radio frequency energy and, if not installed and used in accordance with the instruction manual, may cause harmful interference to radio communications. Operation of this equipment in a residential area is likely to cause harmful interference, in which case the user will be required to correct the interference at his own expense.

Notice 1

The changes or modifications not expressly approved by the party responsible for compliance could void the user's authority to operate the equipment.

Notice 2

Shielded interface cables and A.C. power cord, if any, must be used in order to comply with the emission limits.

VOIR LA NOTICE D'INSTALLATION AVANT DE RACCORDER AU RESEAU.

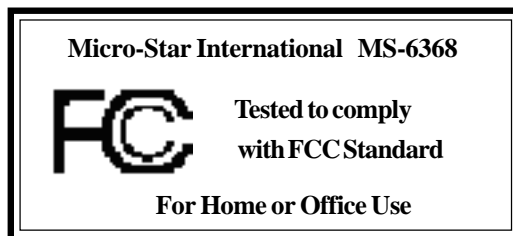

Edition

October 2001

Copyright Notice

The material in this document is the intellectual property of **MICRO-STAR INTERNATIONAL**. We take every care in the preparation of this document, but no guarantee is given as to the correctness of its contents. Our products are under continual improvement and we reserve the right to make changes without notice.

Trademarks

All trademarks used in this manual are the property of their respective owners.

Intel and Pentium are registered trademarks of Intel Corporation.

PS/2 and OS/2 are registered trademarks of IBM Corporation.

Windows 98/2000/ME and Windows NT are registered trademarks of Microsoft.

Netware is a registered trademark of Novell.

Award is a registered trademark of Award Software Inc.

Revision History

Revision	Revision History	Date
5.0	First release for PCB 5.X	October 2001

Safety Instructions

1. Always read the safety instructions carefully.
2. Keep this User's Manual for future reference.
3. Keep this equipment away from humidity.
4. Lay this equipment on a reliable flat surface before setting it up.
5. The openings on the enclosure are for air convection hence protects the equipment from overheating. **DO NOT COVER THE OPENINGS.**
6. Make sure the voltage of the power source and adjust properly 110/220V before connecting the equipment to the power inlet.
7. Place the power cord such a way that people can not step on it. Do not place anything over the power cord.
8. Always Unplug the Power Cord before inserting any add-on card or module.
9. All cautions and warnings on the equipment should be noted.
10. Never pour any liquid into the opening that could damage or cause electrical shock.
11. If any of the following situations arises, get the equipment checked by a service personnel:
 - The power cord or plug is damaged
 - Liquid has penetrated into the equipment
 - The equipment has been exposed to moisture
 - The equipment has not work well or you can not get it work according to User's Manual.
 - The equipment has dropped and damaged
 - If the equipment has obvious sign of breakage
12. **DO NOT LEAVE THIS EQUIPMENT IN AN ENVIRONMENT UNCONDITIONED, STORAGE TEMPERATURE ABOVE 60°C (140°F), IT MAY DAMAGE THE EQUIPMENT.**



CAUTION: Danger of explosion if battery is incorrectly replaced. Replace only with the same or equivalent type recommended by the manufacturer.

CONTENTS

Chapter 1. Introduction	1-1
Mainboard Specification	1-2
Mainboard Layout	1-4
Quick Components Guide	1-5
Key Features	1-6
Chapter 2. Hardware Setup	2-1
Central Processing Unit: CPU	2-2
CPU Installation Procedures	2-2
CPU Core Speed Derivation Procedure	2-3
Memory	2-4
Introduction to SDRAM	2-4
DIMM Modules Combination	2-5
Installing DIMM Modules	2-5
Power Supply	2-6
ATX 20-Pin Power Supply	2-6
Back Panel	2-7
Mouse Connector	2-7
Keyboard Connector	2-8
USB Connectors	2-8
Parallel Port Connector	2-9
Serial Port Connector: COM 1 & COM 2	2-10
VGA DB 15 Pin Connector	2-10
Joystick/Midi Connectors	2-11
Audio Port Connectors	2-11
LAN Jack (RJ-45) (Optional)	2-11
Floppy Disk Drive Connector: FDD	2-12
USB Front Panel Connector: USB2	2-12
Connectors	2-12
Hard Disk Connectors: IDE1 & IDE2	2-13

Case Connector: JFP1	2-14
Wake On Ring Connector: JMDM1	2-16
Wake On LAN Connector: WOL1	2-16
Fan Power Connectors: CPUFAN/SYSFAN	2-17
CD-In/Aux Line-In/Modem-In Connector: CD_IN/AUX_IN/ MODEM_IN	2-18
IrDA Infrared Module Connector: JIR1	2-19
Front Panel Audio Connector: FRONT AUDIO	2-20
Jumpers	2-22
Clear CMOS Jumper: JBIOS	2-22
BIOS Flash Jumper: JBIOS1	2-23
Slots	2-24
PCI Slots	2-24
CNR (Communication Network Riser) Slot	2-24
ISA Slot (Optional)	2-24
PCI Interrupt Request Routing	2-25
Chapter 3. AWARD® BIOS Setup	3-1
Entering Setup	3-2
Control Keys	3-2
Getting Help	3-3
The Main Menu	3-4
Standard CMOS Features	3-6
Advanced BIOS Features	3-9
Advanced Chipset Features	3-13
Integrated Peripherals	3-17
Power Management Setup	3-22
PnP/PCI Configurations	3-28
PC Health Status	3-30
Frequency/Voltage Control	3-31
Load Fail-Safe/Optimized Defaults	3-32

Set Supervisor/User Password	3-34
Save & Exit Setup	3-36
Exit Without Saving	3-37
Chapter 4. Installing Drivers	4-1
VIA Driver Installation for Windows® 98SE/2000/ME/NT4.0	4-2
Realtek® 8100L Fast Ethernet Controller	4-4
Glossary	G-1

Introduction

1

Thank you for purchasing the MS-6368 (v5.X) Micro-ATX motherboard. The mainboard, based on **VIA® Apollo PLE133T (VT8601T & VT82C686B)** chipsets, is a high-performance computer mainboard designed for Intel® Celeron/Pentium® III (including Tualatin)/VIA C3™ processor in the 370 pin package that provides a cost-effective and professional value PC platform solution.

This chapter includes the following topics:

Mainboard Specification	1-2
Mainboard Layout	1-4
Quick Components Guide	1-5
Key Features	1-6

Chapter 1

Mainboard Specification

CPU

- Socket 370 for Intel® Celeron™/ Tualatin / Pentium III (FC-PGA) processor and VIA C3™ processor
- Supports 500MHz, 533MHz., 550MHz, 667MHz, 700MHz, 750MHz, 800MHz, 850MHz, 933MHz, 950MHz, 1GHz, 1.13GHz, 1.2GHz and above

Chipset

- VIA® PLE133T VT8601T chipset (552 BGA)
 - FSB @ 133MHz
 - Integrated Trident Blade 2D/3D video accelerator
 - PCI Advanced high performance memory controller
 - Supports PC100/133 SDRAM, VCM & ESDRAM technology
- VIA® VT686B chipset (352 BGA)
 - Enhanced Power Management Features
 - Integrated Super I/O (FDC, LPT, COM 1/2, and IR)
 - Dual bus Master IDE Ultra DMA33/66/100
 - Integrated Hardware Soundblaster
 - Direct Sound AC97 Audio
 - ACPI

Clock Generator

- 66.6MHz, 100MHz and 133MHz clocks are supported

MainMemory

- Supports four memory banks using two 168-pin unbuffered DIMM
- Supports a maximum memory size of 1GB (32M x 8)
- Supports 3.3v SDRAM DIMM

Slots

- One CNR (Communication Network Riser) slot
- Three 32-bit Master PCI Bus slots
- Supports 3.3v/5v PCI bus Interface
- One ISA slot (optional)

On-Board IDE

- An IDE controller on the VIA® VT82C686B chipset provides IDE HDD/CD-ROM with PIO, Bus Master and Ultra DMA 33/66/100 operation modes.
- Can connect up to four IDE devices

Audio

- Audio controller integrated in 686B chipset
- SW Audio Codec VIA 1611A
 - Front Audio Pin Header onboard

Network

- Realtek 8100L (optional)

On-Board Peripherals

- On-Board Peripherals include:
 - 1 floppy port supports 2 FDDs with 360K, 720K, 1.2M, 1.44M and 2.88Mbytes.
 - 2 serial ports (COMA + COMB)
 - 1 parallel port supports SPP/EPP/ECP mode
 - 4 USB ports (2 Rear Connectors/USB Front Pin Header)
 - 1 IrDA connector for SIR/CIR/FIR/ASKIR/HPSIR
 - 1 VGA connector
 - 1 Audio/Game port

BIOS

- The mainboard BIOS provides “Plug & Play” BIOS which detects the peripheral devices and expansion cards of the board automatically.
- The mainboard provides a Desktop Management Interface (DMI) function which records your mainboard specifications.

Dimension

- Micro-ATX Form Factor: 24.5cm (L) x 21cm (W)

Mounting

- 6 mounting holes

Mainboard Layout

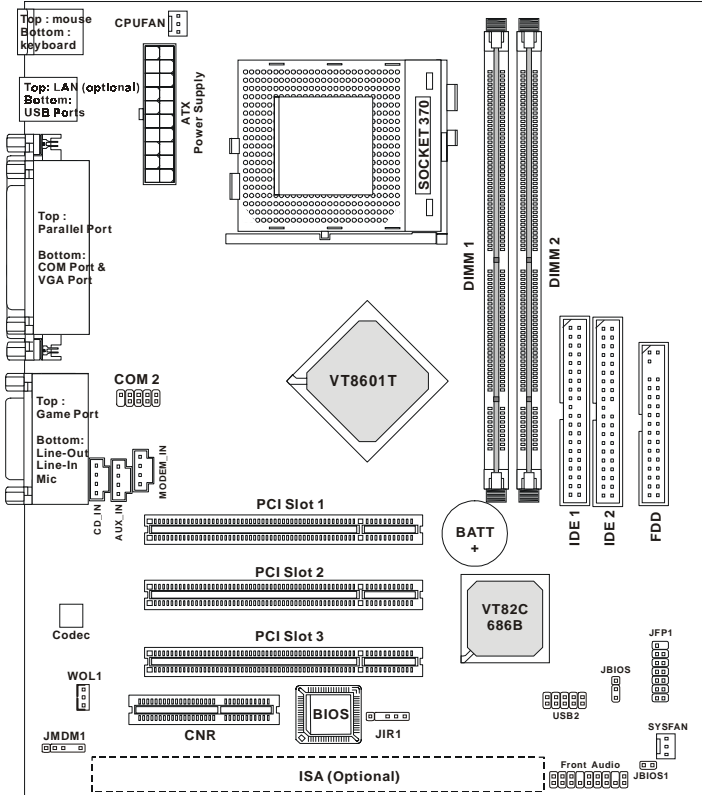

MS-6368 (v5.X) Micro-ATX Mainboard

Quick Components Guide

Component	Function	Reference
DIMM 1~2	Installing memory modules	See p. 2-4~2-5
Socket 370	Installing CPU	See p. 2-2~2-3
CPUFAN	Connecting to CPUFAN	See p. 2-17
SYSFAN	Connecting to SYSFAN	See p. 2-17
ATX Power Supply	Installing power supply	See p. 2-6
IDE1& IDE2	Connecting to IDE hard disk drive	See p.2-13
FDD	Connecting to floppy disk drive	See p.2-12
USB2	Connecting to USB interfaces	See p. 2-12
PCI Slot 1~3	Installing expansion cards	See p. 2-24
ISA Slot	Installing ISA cards	See p. 2-24
CNR Slot	Installing expansion cards	See p. 2-24
JFP1	Connecting to the case	See p. 2-14
JMDM1	Connecting to a modem card	See p. 2-16
WOL1	Connecting to an LAN card	See p. 2-16
JIR1	Connecting to IrDA infrared module	See p. 2-19
JBIOS	Clearing CMOS data	See p. 2-22
JBIOS1	Setting BIOS flash function	See p. 2-23
Front Audio	Connecting to an Audio connector	See p. 2-20

Chapter 1

Key Features

- Micro-ATX Form Factor
- CPU: Socket 370 for Intel® Celeron™/Pentium® III (including Tualatin)/VIA C3™ Processor
- Memory: 2 SDRAM DIMMs
- Slot: 1 CNR slot, 3 PCI slots, 1 ISA slot (optional)
- I/O: 2 serial ports (COM2 is the onboard pin header), 1 parallel port, 4 USB ports, 1 floppy port, 1 IrDA connector, 1 Audio/Game port, 1 VGA port, 1 LAN jack (optional)
- LAN Wake up Function
- Modem (External/Internal) Ring Wake up Function
- Chip integrated audio
- PC 2001 compliant
- Supports PCI 2.2

Hardware Setup

2

This chapter provides you with the information about hardware setup procedures. While doing the installation, be careful in holding the components and follow the installation procedures. For some components, if you install in the wrong orientation, the components will not work properly.

Use a grounded wrist strap before handling computer components. Static electricity may damage the components.

This chapter contains the following topics:

Central Processing Unit (CPU)	2-2
Memory	2-4
Power Supply	2-6
Back Panel	2-7
Connectors	2-12
Jumpers	2-22
Slots	2-24

Chapter 2

Central Processing Unit: CPU

The mainboard supports Intel® Celeron™, Pentium® III (including Tualatin) and VIA C3™ processor. The mainboard uses a CPU socket called Socket 370 for easy CPU installation. Make sure the CPU has a Heat Sink and a cooling fan attached on top to prevent overheating. If you do not find the Heat Sink and cooling fan, contact your dealer to purchase and install them before turning on the computer.

CPU Installation Procedures

1. Pull the lever sideways away from the socket. Then, raise the lever up to a 90-degree angle.

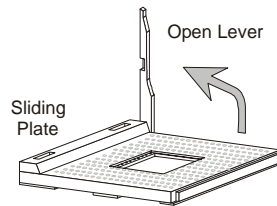

2. Look for the gold arrow. The gold arrow should point towards the end of lever. The CPU will only fit in the correct orientation.

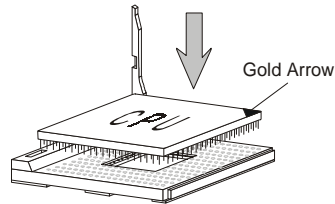

3. Hold the CPU down firmly, and then close the lever to complete the installation.

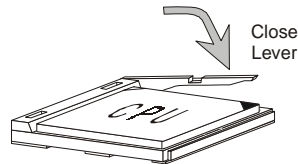

WARNING!

Overheating will seriously damage the CPU and system, always make sure the cooling fan can work properly to protect the CPU from overheating.

CPU Core Speed Derivation Procedure

The mainboard can automatically set the CPU Host Bus Frequency Clock.

If	CPU Clock	=	100MHz
	Core/Bus ratio	=	7
then	CPU core speed	=	Host Clock x Core/Bus ratio
		=	100MHz x 7
		=	700MHz



Overclocking

WARNING!

*This motherboard is designed to support overclocking. However, please make sure your components are able to tolerate such abnormal setting, while doing overclocking. Any attempt to operate beyond product specifications is not recommended. **We do not guarantee the damages or risks caused by inadequate operation or beyond product specifications.***

Chapter 2

Memory

The mainboard supports a maximum memory size of 1GB. It provides two 168-pin **unbuffered** SDRAM DIMM (Double In-Line Memory Module) sockets and supports 64MB to 512MB technology.

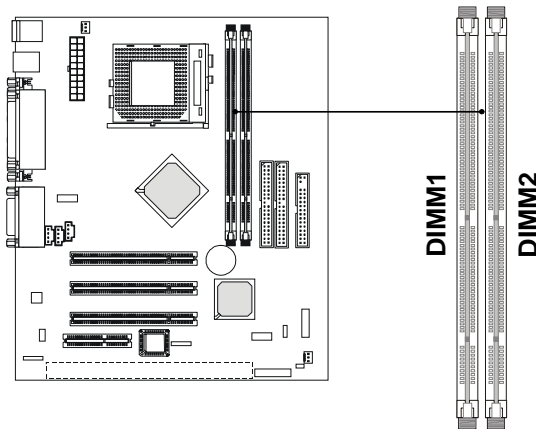

Introduction to SDRAM

Synchronous DRAM (SDRAM) is a type of dynamic RAM memory chip that has been widely used starting in the latter part of the 1990s. SDRAMs are based on standard dynamic RAM chips, but have sophisticated features that make them considerably faster. First, SDRAM chips are fast enough to be synchronized with the CPU's clock, which eliminates wait states. Second, the SDRAM chip is divided into two cell blocks, and data is interleaved between the two so that while a bit in one block is being accessed, the bit in the other is being prepared for access. This allows SDRAM to burst the second and subsequent, contiguous characters at a rate of 10ns, compared to 60ns for the first character.

SDRAM provides 800 MBps or 1 GBps data transfer depending on whether the bus is 100MHz or 133MHz.

DIMM Modules Combination

At least one DIMM module should be installed on the motherboard. Memory modules can be installed on the slots in any order. The single-/double-sided module each DIMM slot supports is listed below:

Socket	Memory Module	Total Memory
DIMM 1 (Bank0 & Bank1)	S/D	64MB ~ 512MB
DIMM 2 (Bank2 & Bank3)	S/D	64MB ~ 512MB
Maximum System Memory Supported		64MB ~ 1GB

S: Single Side

D: Double Side

Installing DIMM Modules

1. The DIMM slot has 2 Notch Keys “VOLT and DRAM”, so the DIMM memory module can only fit in one direction.



Front View



Rear View

2. Insert the DIMM memory module vertically into the DIMM slot. Then push it in.

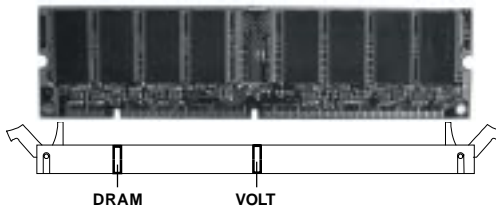

3. The plastic clip at each side of the DIMM slot will automatically close.

Chapter 2

Power Supply

The mainboard supports ATX power supply for the power system. Before connecting to the power supply, always make sure that all components are installed properly and no damage will be caused.

ATX 20-Pin Power Supply

This connector allows you to connect to an ATX power supply. To connect to the ATX power supply, make sure the power supply connector is installed in the right orientation and the pins are aligned. Then push down the power supply connector firmly into the power connector on the mainboard.

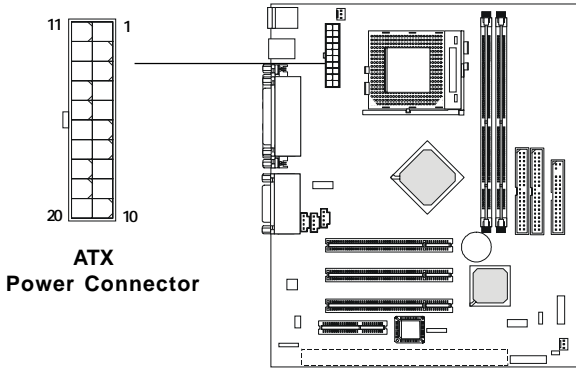

PIN	SIGNAL	PIN	SIGNAL
1	3.3V	11	3.3V
2	3.3V	12	-12V
3	GND	13	GND
4	5V	14	PS_ON
5	GND	15	GND
6	5V	16	GND
7	GND	17	GND
8	PW_OK	18	-5V
9	5V_SB	19	5V
10	12V	20	5V

Back Panel

The Back Panel provides the following connectors:

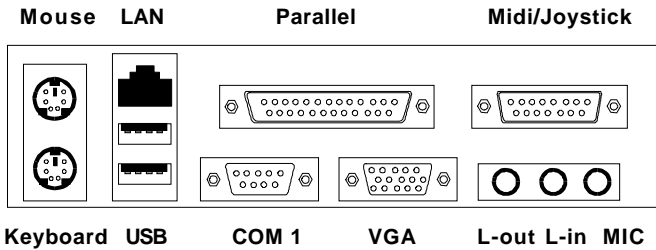

Mouse Connector

The mainboard provides a standard PS/2[®] mouse mini DIN connector for attaching a PS/2[®] mouse. You can plug a PS/2[®] mouse directly into this connector.

PS/2 Mouse (6-pin Female)

Pin Definition

PIN	SIGNAL	DESCRIPTION
1	Mouse DATA	Mouse DATA
2	NC	No connection
3	GND	Ground
4	VCC	+5V
5	Mouse Clock	Mouse clock
6	NC	No connection

Chapter 2

Keyboard Connector

The mainboard provides a standard PS/2® keyboard mini DIN connector for attaching a PS/2® keyboard. You can plug a PS/2® keyboard directly into this connector.

Pin Definition		
PIN	SIGNAL	DESCRIPTION
1	Keyboard DATA	Keyboard DATA
2	NC	No connection
3	GND	Ground
4	VCC	+5V
5	Keyboard Clock	Keyboard clock
6	NC	No connection

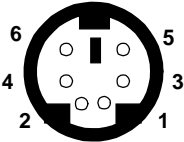

PS/2 Keyboard (6-pin Female)

USB Connectors

The mainboard provides a UHCI (Universal Host Controller Interface) Universal Serial Bus root for attaching USB devices such as keyboard, mouse or other USB-compatible devices. You can plug the USB device directly into the connector.

USB Port Description		
PIN	SIGNAL	DESCRIPTION
1	VCC	+5V
2	-Data 0	Negative Data Channel 0
3	+Data0	Positive Data Channel 0
4	GND	Ground
5	VCC	+5V
6	-Data 1	Negative Data Channel 1
7	+Data 1	Positive Data Channel 1
8	GND	Ground

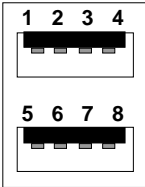

USB Ports

Parallel Port Connector

The mainboard provides a 25-pin female centronic connector for LPT. A parallel port is a standard printer port that supports Enhanced Parallel Port (EPP) and Extended Capabilities Parallel Port (ECP) mode.

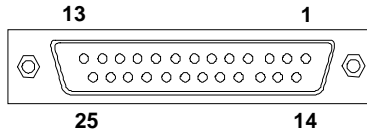

Pin Definition

PIN	SIGNAL	DESCRIPTION
1	STROBE	Strobe
2	DATA0	Data0
3	DATA1	Data1
4	DATA2	Data2
5	DATA3	Data3
6	DATA4	Data4
7	DATA5	Data5
8	DATA6	Data6
9	DATA7	Data7
10	ACK#	Acknowledge
11	BUSY	Busy
12	FE	Paper End
13	SELECT	Select
14	AUTOFEED#	Automatic Feed
15	ERR#	Error
16	INIT#	Initialize Printer
17	SLIN#	Select In
18	GND	Ground
19	GND	Ground
20	GND	Ground
21	GND	Ground
22	GND	Ground
23	GND	Ground
24	GND	Ground
25	GND	Ground

Chapter 2

Serial Port Connector: COM 1 & COM 2

The mainboard has one 9-pin male DIN connector COM 1 and one 9-pin COM 2 pin header, which allows you to attach a serial port bracket. You can attach a serial mouse or other serial devices to serial ports.

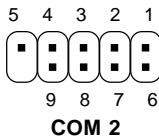
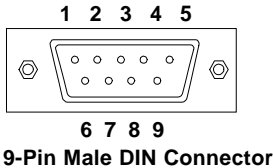

Pin Definition

PIN	SIGNAL	DESCRIPTION
1	DCD	Data Carry Detect
2	SIN	Serial In or Receive Data
3	SOUT	Serial Out or Transmit Data
4	DTR	Data Terminal Ready)
5	GND	Ground
6	DSR	Data Set Ready
7	RTS	Request To Send
8	CTS	Clear To Send
9	RI	Ring Indicate

VGA DB 15 Pin Connector

The mainboard provides one DB 15-pin female connector to connect a VGA monitor.

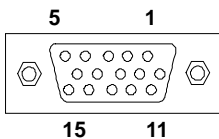

Pin Definition

Analog Video Display Connector (DB-15S)	
PIN	SIGNAL DESCRIPTION
1	Red
2	Green
3	Blue
4	Not used
5	Ground
6	Ground
7	Ground
8	Ground
9	Power
10	Ground
11	Not used
12	SDA
13	Horizontal Sync
14	Vertical Sync
15	SCL

Joystick/Midi Connectors

You can connect a joystick or game pad to this connector.

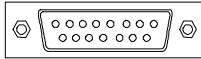

Audio Port Connectors

Line Out is to connect speakers or headphones. **Line In** is a connector for external CD player, Tape player or other audio devices. **Mic** is used to connect to a microphone.

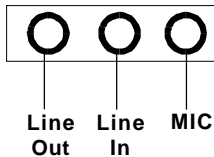

LAN Jack (RJ-45) (Optional)

The mainboard provides one standard RJ-45 jack for connection to Local Area Network (LAN). You can connect a network cable to the LAN jack.



LAN RJ-45 Jack

Pin Definition

PIN	SIGNAL	DESCRIPTION
1	TDP	Transmit Differential Pair
2	TDN	Transmit Differential Pair
3	RDP	Receive Differential Pair
4	NC	Not Used
5	NC	Not Used
6	RDN	Receive Differential Pair
7	NC	Not Used
8	NC	Not Used

Chapter 2

Connectors

The mainboard provides connectors to connect to FDD, IDE HDD, case, modem, LAN, USB Ports, IR module and CPU/System FAN.

Floppy Disk Drive Connector: FDD

The mainboard provides a standard floppy disk drive connector that supports 360K, 720K, 1.2M, 1.44M and 2.88M floppy disk types.

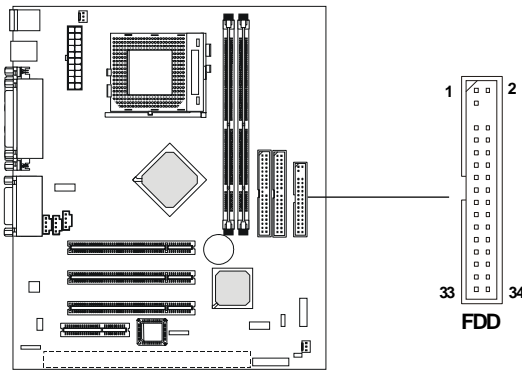

USB Front Panel Connector: USB2

The mainboard provides one Front USB (Universal Serial Bus) pin header that allows you to connect optional USB ports for Front Panel.

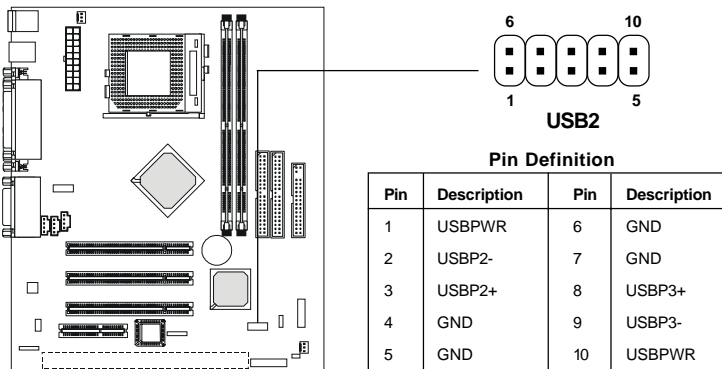

Hard Disk Connectors: IDE1 & IDE2

The mainboard uses an IDE controller on the VIA® VT82C686B chipset that provides PIO mode 0-4, Bus Master, and Ultra DMA 33/66/100 modes. It has two HDD connectors IDE1 (Primary) and IDE2 (Secondary). You can connect up to four hard disk drives, CD-ROM or 120MB Floppy to IDE1 and IDE2.

IDE1 (Primary IDE Connector)

- The first hard disk drive should always be connected to IDE1. You can connect a Master and a Slave drive to IDE1.

IDE2 (Secondary IDE Connector)

- You can connect a Master and a Slave drive to IDE2.

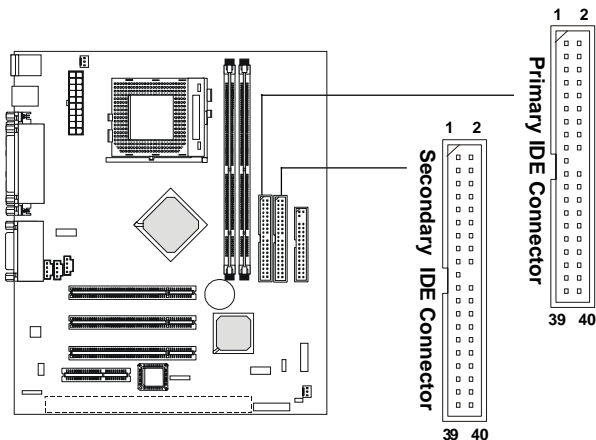

TIP

If you install two hard disks on cable, you must configure the second drive to Slave mode by setting its jumper. Refer to the hard disk documentation supplied by hard disk vendors for jumper setting instructions.

Chapter 2

Case Connector: JFP1

The case connector block JFP1 allows you to connect to the Power Switch, Reset Switch, Speaker, Power LED and HDD LED on the case.

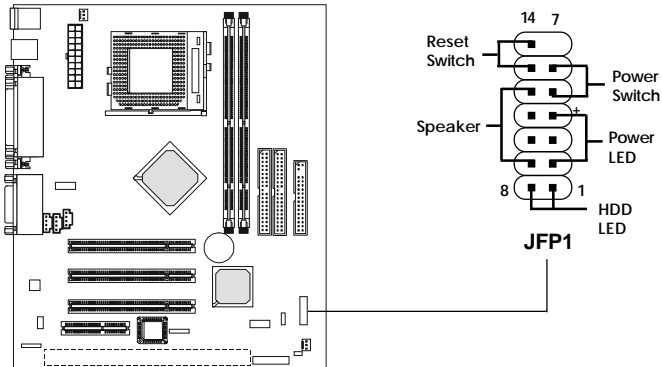

JFP1 Pin Definition

Pin	Description	Pin	Description
1	HDD+	8	HDD-
2	SLED-	9	SPK-
3	PLED-	10	BUZ+
4	PLED+	11	BUZ-
5	PWSW+	12	SPK+
6	PWSW-	13	RST+
7	NC	14	RST-

Power Switch

Connect to a 2-pin push button switch. Pressing this button can turn the system power on or off.

Reset Switch

Reset switch is used to reboot the system rather than turning the power ON/OFF. Avoid rebooting while the HDD is working. You can connect the Reset switch from the system case to this pin.

PowerLED

The Power LED is lit while the system power is on.

Speaker

Speaker from the system case is connected to this pin.

HDDLED

HDD LED shows the activity of a hard disk drive. Avoid turning the power off while the HDD is working. You can connect the HDD LED from the system case to this pin.

Chapter 2

Wake On Ring Connector: JMDM1

This connector allows you to connect to a modem card with Wake On Ring function. The connector will power up the system when a signal is received through the modem card.

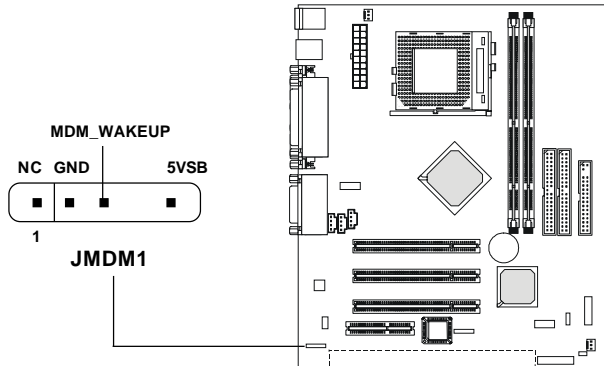

Wake On LAN Connector: WOL1

This connector allows you to connect to a LAN card with Wake On LAN function. You can wake up the computer via remote control through a local area network.

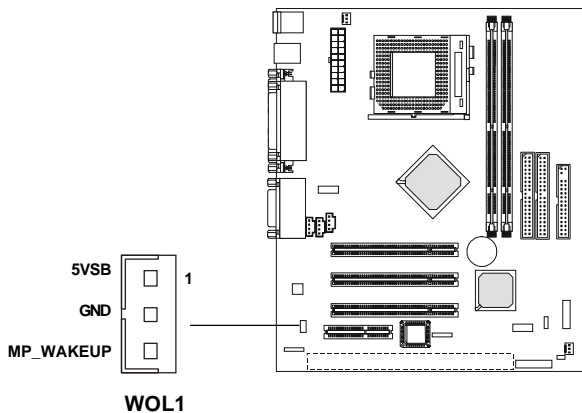

Fan Power Connectors: CPUFAN/SYSFAN

The CPUFAN (processor fan) and SYSFAN (system fan) support system cooling fan with +12V. It supports three-pin head connector. When connecting the wire to the connectors, always take note that the red wire is the positive and should be connected to the +12V, the black wire is Ground and should be connected to GND. If the mainboard has a System Hardware Monitor chipset on-board, you must use a specially designed fan with speed sensor to take advantage of the CPU fan control.

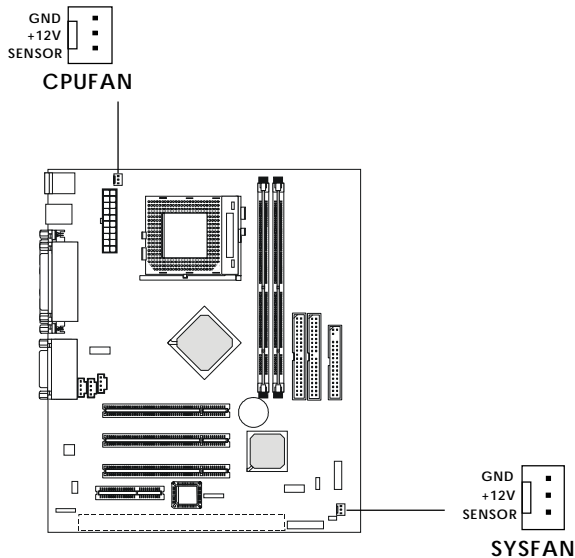

Note:

1. Always consult the vendor for proper CPU cooling fan.
2. CPU Fan supports the fan control. You can install the PC Alert utility that will automatically control the CPU Fan speed according to the actual CPU temperature.

Chapter 2

CD-In/Aux Line-In/Modem-In Connector: CD_IN/AUX_IN/MODEM_IN

CD_IN connector is for CD-ROM audio connector.

AUX_IN connector is for DVD add-on card with Line-in connector.

MODEM_IN connector is for modem with internal audio connector.

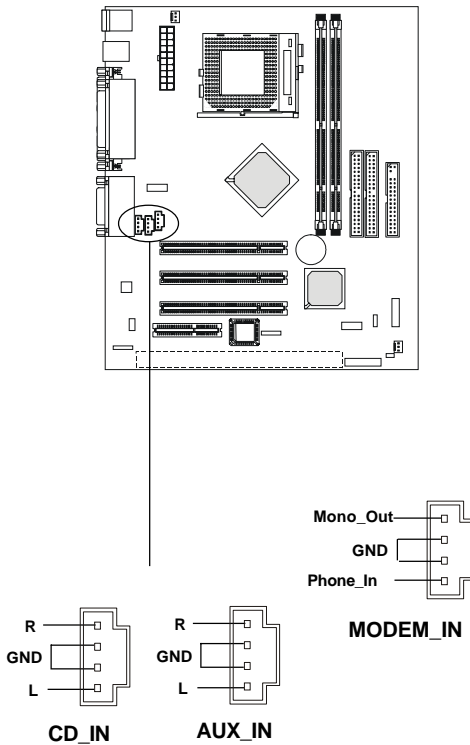

Note:

Mono_Out is connected to the Modem speaker-out connector.

Phone_In is connected to the Modem Microphone-In connector.

IrDA Infrared Module Connector: JIR1

This connector allows you to connect an IrDA Infrared module. You must configure the setting through the BIOS setup to use the IR function.

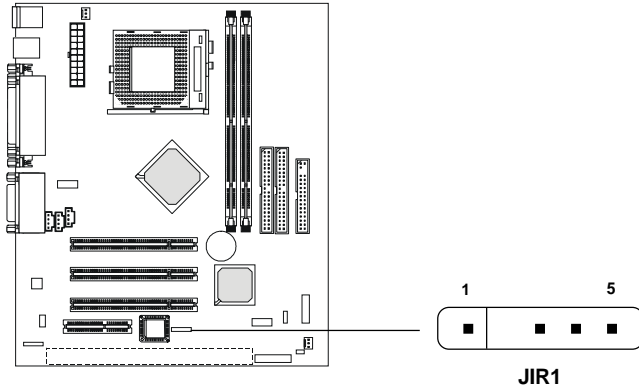

Pin Definition

Pin	Signal
1	VCC
2	NC
3	IRRX
4	GND
5	IRTX

Chapter 2

Front Panel Audio Connector: FRONT AUDIO

You can connect an optional audio connector to the Front Panel Audio Header.

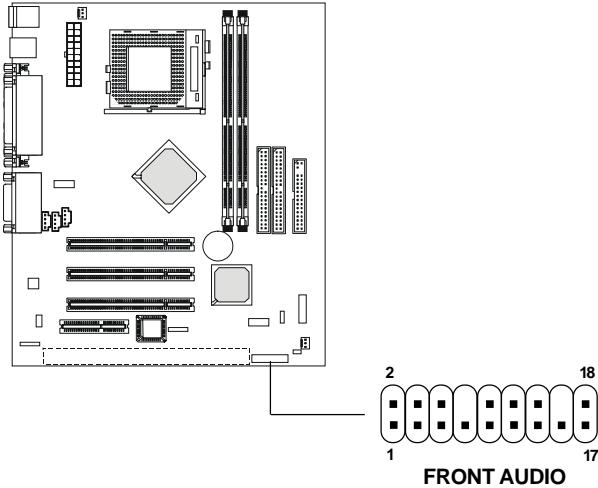

PIN	Description	PIN	Description
1	Active Line Out (R)	2	Active Line Out (L)
3	GND (ALO)	4	GND (ALO)
5	GND (+12)	6	GND (+12)
7	+12V (1A)	8	NC
9	MIC	10	GND (MIC)
11	Front Line Out (R)	12	Line Next (R)
13	Front Line Out (L)	14	Line Next (L)
15	GND (FLO)	16	NC
17	Line In (R)	18	Line In (L)

Hardware Setup



Note: To have the Line-out connector on the back panel work properly, you need to place the jumper on the pin# 11~14 of the FRONT AUDIO connector. Otherwise, this Line-out connector will not function and nothing can be heard through speakers or headphones attached to the connector. But front panel audio connector is enabled at this point and allows you to connect speakers or headphones.

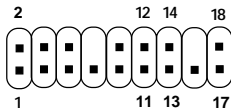

(OPEN pin# 11~14)

- Disable Line-out connector on the back panel
- Enable Front Panel Audio Connector

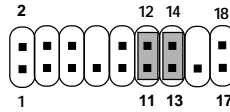

(SHORT pin# 11~14)

- Enable Line-out connector on the back panel
- Disable Front Panel Audio Connector

Jumpers

The motherboard provides the following jumpers for you to set the computer's function. This section describes how to change your motherboard's function through the use of jumpers.

Clear CMOS Jumper: JBIOS

There is a CMOS RAM on board that has a power supply from external battery to keep the data of system configuration. With the CMOS RAM, the system can automatically boot OS every time it is turned on. If you want to clear the system configuration stored in the CMOS RAM, use the JBIOS (Clear CMOS Jumper) to clear data. Follow the instructions below to clear the data:

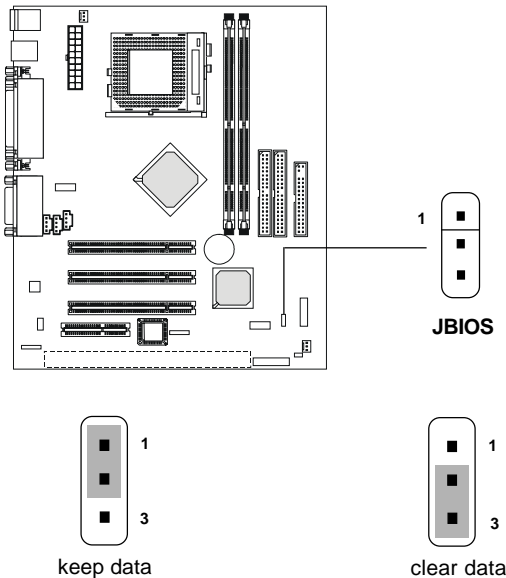

WARNING!

You can clear CMOS by shorting 2-3 pin while the system is off. Then return to 1-2 pin position. Avoid clearing the CMOS while the system is on; it will damage the mainboard.

BIOS Flash Jumper: JBIOS1

This jumper is used to lock or unlock the boot block area on BIOS. When unlocked, the BIOS boot block area can be updated. When locked, the BIOS boot block area can not be updated.

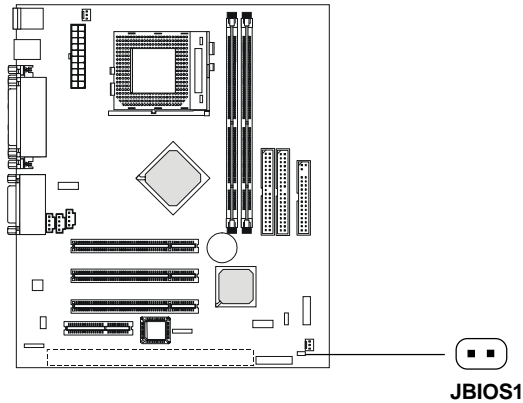

BIOS Flash Locked
(Write Protect)



BIOS Flash Unlocked

Chapter 2

Slots

The motherboard provides three 32-bit Master PCI Bus Slots, one CNR and one optional ISA slot.

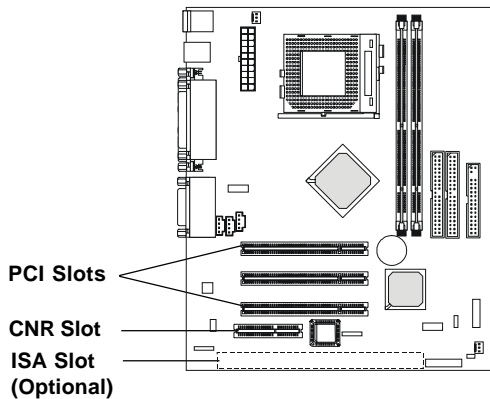

PCI Slots

Three PCI slots allow you to install expansion cards to meet your needs. When adding or removing expansion cards, make sure that you unplug the power supply first. Meanwhile, read the documentation for the expansion card to make any necessary hardware or software settings for the expansion card, such as jumpers, switches or BIOS configuration.

CNR (Communication Network Riser) Slot

The CNR specification is an open industry-standard specification that defines a hardware scalable Original Equipment Manufacturer (OEM) main-board riser board and interface, which **supports audio and modem only**.

ISA Slot (Optional)

This slot allows you to install ISA expansion card.

PCI Interrupt Request Routing

The IRQ, abbreviation of interrupt request line and pronounced I-R-Q, are hardware lines over which devices can send interrupt signals to the microprocessor. The PCI/USB/AC97 IRQ pins are typically connected to the PCI bus INTA#-INTD# pins as follows:

	Order 1	Order 2	Order 3	Order 4
PCI Slot 1	INT A#	INT B#	INT C#	INT D#
PCI Slot 2	INT B#	INT C#	INT D#	INT A#
PCI Slot 3	INT C#	INT D#	INT A#	INT B#
USB-1	INT D#	INT A#	INT B#	INT C#
USB-2	INT D#	INT A#	INT B#	INT C#
AC97	INT C#	INT D#	INT A#	INT B#

PCI Slot 3 & AC97 codec shared.

PCI Slot 1~3: Bus Master.

AWARD® BIOS Setup

3

The mainboard uses AWARD® BIOS ROM that provides a Setup utility for users to modify the basic system configuration. The information is stored in a battery-backed CMOS RAM so it retains the Setup information when the power is turned off.

The chapter contains the following topics:

Entering Setup	3-2
Control Keys	3-2
Getting Help	3-3
The Main Menu	3-4
Standard CMOS Features	3-6
Advanced BIOS Features	3-9
Advanced Chipset Features	3-13
Integrated Peripherals	3-17
Power Management Setup	3-22
PnP/PCI Configurations	3-28
PC Health Status	3-30
Frequency/Voltage Control	3-31
Load Fail-Safe/Optimized Defaults	3-32
Set Supervisor/User Password	3-34
Save & Exit Setup	3-36
Exit Without Saving	3-37

Chapter 3

Entering Setup

Power on the computer and the system will start POST (Power On Self Test) process. When the message below appears on the screen, press key to enter Setup.

Hit DEL if you want to run SETUP

If the message disappears before you respond and you still wish to enter Setup, restart the system by turning it OFF and On or pressing the RESET button. You may also restart the system by simultaneously pressing <Ctrl>, <Alt>, and <Delete> keys.

Control Keys

<↑>	Move to the previous item
<↓>	Move to the next item
<←>	Move to the item in the left hand
<→>	Move to the item in the right hand
<Enter>	Select the item
<Esc>	Jumps to the Exit menu or returns to the main menu from a submenu
<+/PU>	Increase the numeric value or make changes
<-/PD>	Decrease the numeric value or make changes
<F1>	General help, only for Status Page Setup Menu and Option Page Setup Menu
<F5>	Restore the previous CMOS value from CMOS, only for Option Page Setup Menu
<F6>	Load the default CMOS value from Fail-Safe default table, only for Option Page Setup Menu
<F7>	Load Optimized defaults
<F10>	Save all the CMOS changes and exit

Getting Help

After entering the Setup utility, the first screen you see is the Main Menu.

Main Menu

The main menu displays the setup categories the BIOS supplies. You can use the arrow keys (↑↓) to select the item. The on-line description for the selected setup category is displayed on the bottom of the screen.

Sub-Menu

If you find a right pointer symbol appears to the left of certain fields (as shown in the right view), that means a sub-menu containing additional options for the field can be launched from this field. To enter the sub-menu, highlight the field and press <Enter>. Then you can use control keys to move between and change the settings of the sub-menu. To return to the main menu, press <Esc>.



```
▶ IDE Primary Master
▶ IDE Primary Slave
▶ IDE Secondary Master
▶ IDE Secondary Slave
```

General Help <F1>

The BIOS setup program provides a General Help screen. You can call up this screen from any menu by simply pressing <F1>. The Help screen lists the appropriate keys to use and the possible selections for the highlighted item. Press <Esc> to exit the Help screen.

Chapter 3

The Main Menu

Once you enter AWARD® BIOS CMOS Setup Utility, the Main Menu will appear on the screen. The Main Menu displays eleven configurable functions and two exit choices. Use arrow keys to move among the items and press <Enter> to enter the sub-menu.



Standard CMOS Features

Use this menu for basic system configurations, such as time, date etc.

Advanced BIOS Features

Use this menu to setup the items of Award® special enhanced features.

Advanced Chipset Features

Use this menu to change the values in the chipset registers and optimize your system's performance.

Integrated Peripherals

Use this menu to specify your settings for integrated peripherals.

Power Management Setup

Use this menu to specify your settings for power management.

PnP/PCI Configurations

This entry appears if your system supports PnP/PCI.

PC Health Status

This entry displays the current status of your PC.

Frequency/Voltage Control

Use this menu to specify your settings for frequency/voltage control.

Load Fail-Safe Defaults

Use this menu to load the BIOS default values for the minimal/stable performance of your PC.

Load Optimized Defaults

Use this menu to load the default factory settings for BIOS for optimal system performance.

Supervisor Password

Use this menu to set Supervisor Password.

User Password

Use this menu to set User Password.

Save & Exit Setup

Save changes to CMOS and exit setup.

Exit Without Saving

Abandon all changes and exit setup.

Chapter 3

Standard CMOS Features

The items inside Standard CMOS Features menu are divided into 13 categories. Each category includes none, one or more setup items. Use the arrow keys to highlight the item you want to modify and use the <PgUp> or <PgDn> keys to switch to the value you prefer.



Date

This allows you to set the system to the date that you want (usually the current date). The format is <day><month> <date> <year>.

- day** Day of the week, from Sun to Sat, determined by BIOS. Read-only.
- month** The month from Jan. through Dec.
- date** The date from 1 to 31 can be keyed by numeric function keys.
- year** The year depends on the year of the BIOS.

Time

This allows you to set the system time that you want (usually the current time). The time format is <hour> <minute> <second>.

IDE Primary Master/Primary Slave/Secondary Master/Secondary Slave

Press PgUp/<+> or PgDn/<-> to select the hard disk drive type. The specification of hard disk drive will show up on the right hand according to your selection.

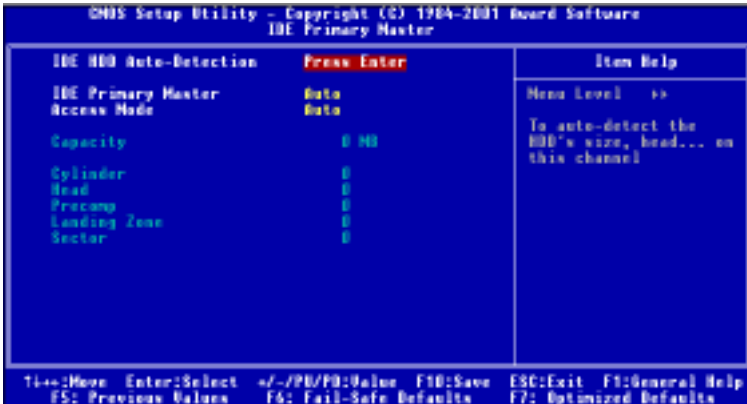

Access Mode	The settings are Auto, CHS, LBA and Large.
Capacity	The formatted size of the storage device.
Cylinder	Number of cylinders.
Head	Number of heads.
Precomp	Write precompensation.
Landing Zone	Cylinder location of the landing zone.
Sector	Number of sectors.

Drive A/B

This item allows you to set the type of floppy drives installed. Available options: *None, 360K, 5.25 in., 1.2M, 5.25 in., 720K, 3.5 in., 1.44M, 3.5 in., 2.88M, 3.5 in.*

Video

The item sets the type of video adapter used for the primary monitor of the system. Available options: *EGA/VGA, CGA 40, CGA 80 and Mono.*

Halt On

The item determines whether the system will stop if an error is detected at

Chapter 3

boot. Available options are:

<i>All Errors</i>	The system stops when any error is detected.
<i>No Errors</i>	The system doesn't stop for any detected error.
<i>All, But Keyboard</i>	The system doesn't stop for a keyboard error.
<i>All, But Diskette</i>	The system doesn't stop for a disk error.
<i>All, But Disk/Key</i>	The system doesn't stop for either a disk or a keyboard error.

Advanced BIOS Features

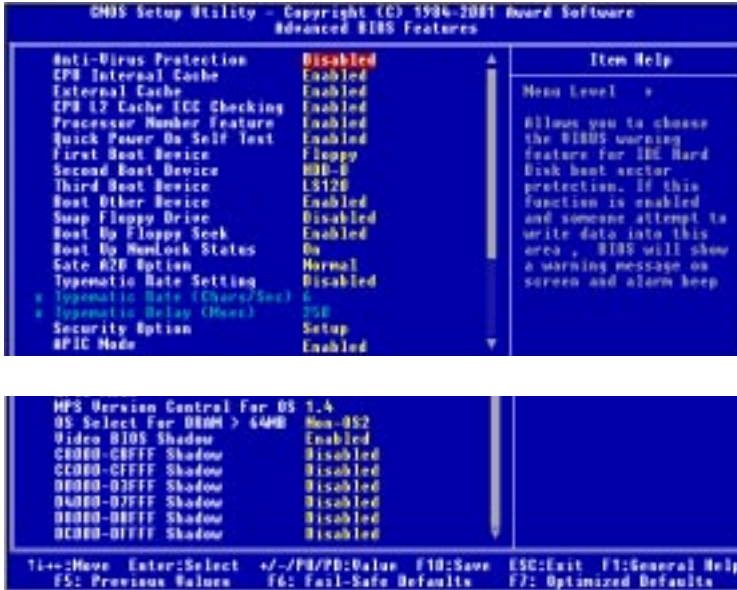

Anti-Virus Protection

The item is to set the Virus Warning feature for IDE Hard Disk boot sector protection. If the function is enabled and any attempt to write data into this area is made, BIOS will display a warning message on screen and beep.

Settings: *Disabled* and *Enabled*.

CPU Internal/External Cache

Cache memory is additional memory that is must faster than conventional DRAM (system memory). When the CPU requests data, the system transfers requested data from main DRAM into cache memory, for even faster access by the CPU. The settings enable/disable the internal cache (also known as L1 or level 1 cache) and external cache (also known as L2 or level 2 cache). Settings: *Enabled* and *Disabled*.

CPU L2 Cache ECC Checking

This allows you to enable or disable the ECC (Error-Correcting Code) feature

Chapter 3

for error detection and correction when data passes through L2 cache memory. Settings: *Enabled* and *Disabled*.

Processor Number Feature

This feature is for Pentium® !!! only. When set to *Enabled*, the system will check CPU Serial Number. Set to *Disabled* if you don't want the system to know the CPU Serial Number.

Quick Power On Self Test

Setting the item to *Enabled* allows the system to shorten boot time since it will skip some check items. Settings: *Enabled* and *Disabled*.

First/Second/Third Boot Device

The items allow you to set the sequence of boot devices where BIOS attempts to load the disk operating system. The settings are:

<i>Floppy</i>	The system will boot from floppy drive.
<i>LS120</i>	The system will boot from LS-120 drive.
<i>HDD-0</i>	The system will boot from the first HDD.
<i>SCSI</i>	The system will boot from the SCSI.
<i>CDROM</i>	The system will boot from the CD-ROM.
<i>HDD-1</i>	The system will boot from the second HDD.
<i>HDD-2</i>	The system will boot from the third HDD.
<i>HDD-3</i>	The system will boot from the fourth HDD.
<i>ZIP</i>	The system will boot from ATAPI ZIP drive.
<i>LAN</i>	The system will boot from the Network drive.
<i>Disabled</i>	Disable this sequence.

Boot Other Device

Setting the option to *Enabled* allows the system to try to boot from other device if the system fails to boot from the 1st/2nd/3rd boot device.

Swap Floppy Drive

Setting to *Enabled* will swap floppy drives A: and B:.

Boot Up Floppy Seek

This setting causes the BIOS to search for floppy disk drives at boot time. When enabled, the BIOS will activate the floppy disk drives during boot

process: the drive activity light will come on and the head will move back and forth once. Settings: *Enabled* and *Disabled*.

Boot Up NumLock Status

This item is to set the Num Lock status when the system is powered on. Setting to *On* will turn on the Num Lock key when the system is powered on. Setting to *Off* will allow end users to use the arrow keys on the numeric keypad. Settings: *On* and *Off*.

Gate A20 Option

This item is to set the Gate A20 status. A20 refers to the first 64KB of extended memory. When the default value *Fast* is selected, the Gate A20 is controlled by Port92 or chipset specific method resulting in faster system performance. When *Normal* is selected, A20 is controlled by a keyboard controller or chipset hardware.

Typematic Rate Setting

This item is used to enable or disable the typematic rate setting including Typematic Rate & Typematic Delay.

Typematic Rate (Chars/Sec)

After Typematic Rate Setting is enabled, this item allows you to set the rate (characters/second) at which the keys are accelerated. Settings: *6, 8, 10, 12, 15, 20, 24* and *30*.

Typematic Delay (Msec)

This item allows you to select the delay between when the key was first pressed and when the acceleration begins. Settings: *250, 500, 750* and *1000*.

Security Option

This specifies the type of BIOS password protection that is implemented. Setting options are described below:

Chapter 3

Option	Description
Setup	The password prompt appears only when end users try to run Setup.
System	A password prompt appears every time when the computer is powered on or when end users try to run Setup.

APICMode

This field is used to enable or disable the APIC (Advanced Programmable Interrupt Controller). Due to compliance to PC2001 design guide, the system is able to run in APIC mode. Enabling APIC mode will expand available IRQs resources for the system. Settings: *Enabled* and *Disabled*.

MPS Version Control For OS

This field allows you to select which MPS (Multi-Processor Specification) version to be used for the operating system. You need to select the MPS version supported by your operating system. To find out which version to use, consult the vendor of your operating system. Settings: *1.4* and *1.1*.

OS Select for DRAM > 64MB

This allows you to run the OS/2® operating system with DRAM larger than 64MB. When you choose *Non-OS2*, you cannot run the OS/2® operating system with DRAM larger than 64MB. But it is possible if you choose *OS2*.

Video BIOS Shadow

This item sets if the Video BIOS will be copied to RAM and increase video speed accordingly. Settings: *Enabled* and *Disabled*.

C8000-CBFFF/CC000-CFFFF/D0000-D3FFF/D4000-D7FFF/D8000-DBFFF/DC000-DFFFFShadow

These items specify whether the contents of the adapter ROM named in the items will be copied into RAM to improve the performance of ROM firmware for adapters. You need to know the address of each adapter ROM occupies to shadow (copy) it into the correct area of RAM. Settings: *Enabled* and *Disabled*.

Advanced Chipset Features

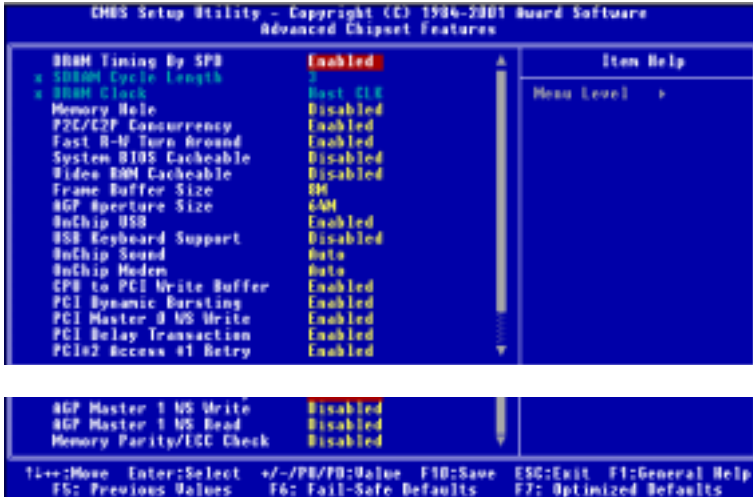

 **Note:** Change these settings only if you are familiar with the chipset.

DRAM Timing By SPD

Selects whether DRAM timing is configured by reading the contents of the SPD (Serial Presence Detect) device on the DRAM module. Setting to *Enabled* makes both SDRAM Cycle Length and DRAM Clock automatically determined by BIOS according to the configurations on the SPD.

SDRAM Cycle Length

The option controls the CAS latency, which determines the timing delay before SDRAM starts a read command after receiving it. Settings: 2 and 3 (clock cycles). 2 increases system performance while 3 provides more stable system performance.

DRAM Clock

The chipset supports synchronous and asynchronous mode between host clock and DRAM clock frequency. The settings are:

Host CLK The DRAM clock will be equal to the Host Clock.

Chapter 3

HCLK-33M The DRAM clock will be equal to the Host Clock minus 33MHz. For example, if the Host Clock is 133MHz, the DRAM clock will be 100MHz.

HCLK+33M The DRAM clock will be equal to the Host Clock plus 33MHz. For example, if the Host Clock is 100MHz, the DRAM clock will be 133MHz.

Memory Hole

In order to improve performance, certain space in memory can be reserved for ISA cards. This memory must be mapped into the memory space below 16MB. When this area is reserved, it cannot be cached. Settings: *15M-16M* and *Disabled*.

P2C/C2P Concurrency

This field enables or disables the PCI to CPU and CPU to PCI concurrency feature, which allows synchronous data transmission from PCI to CPU and vice versa. Selecting *Enabled* will increase system performance.

Fast R-W Turn Around

This is used to control the fast read/write turn around feature for DRAM timing. Settings: *Enabled* and *Disabled*. *Enabled* improves system performance while *Disabled* provides stability.

System BIOS Cacheable

System BIOS ROM at F000h-F0000h is always copied to RAM for faster execution. Selecting *Enabled* allows the contents of F0000h RAM memory segment to be written to and read from cache memory, resulting in better system performance. However, if any program writes to this memory area, a system error may result. Settings: *Enabled* and *Disabled*.

Video RAM Cacheable

Selecting *Enabled* allows caching of the video memory (RAM) at A0000h-AFFFFh, resulting in better video performance. However, if any program writes to this memory area, a memory access error may result. Settings: *Enabled* and *Disabled*.

Frame Buffer Size

Frame Buffer is the video memory that stores data for video display (frame). This field is used to determine the memory size for Frame Buffer. Larger frame buffer size increases video performance. Settings: *2M, 4M* and *8M*.

AGP Aperture Size

Selects the size of the Accelerated Graphics Port (AGP) aperture. Aperture is a portion of the PCI memory address range dedicated for graphics memory address space. Host cycles that hit the aperture range are forwarded to the AGP without any translation. Options: *4M, 8M, 16M, 32M, 64M* and *128M*.

OnChip USB

This is used to enable or disable the USB ports. Settings: *Enabled* and *Disabled*.

USB Keyboard Support

Set to *Enabled* if you need to use an USB keyboard in the operating system that does not support or have any USB driver installed, such as DOS and SCOUnix.

OnChip Sound

Auto allows the mainboard to detect whether an audio device is used. If the device is detected, the onboard audio controller will be enabled; if not, the controller is disabled. Disable the controller if you want to use other controller cards to connect an audio device. Settings: *Auto* and *Disable*.

OnChip Modem

Auto allows the mainboard to detect whether a modem is used. If a modem is detected, the onboard modem controller will be enabled; if not, the controller is disabled. Disable the controller if you want to use other controller cards to connect modems. Settings: *Auto* and *Disable*.

CPU to PCI Write Buffer

When *Enabled*, CPU can write up to four words of data into the PCI write buffer before the CPU must wait for PCI bus cycles to finish. When *Disabled*, the CPU must wait after each write cycle until the PCI bus signals that it is ready to receive more data.

Chapter 3

PCI Dynamic Bursting

When *Enabled*, every write transaction goes to the write buffer. Then burstable transactions burst on the PCI bus and nonburstable transactions do not.

PCI Master 0 WS Write

When *Enabled*, writes to the PCI bus are executed with zero wait state.

PCI Delay Transaction

The chipset has an embedded 32-bit posted write buffer to support delay transactions cycles so that transactions to and from ISA bus are buffered and PCI bus can perform other transactions while ISA transaction is underway. Select *Enabled* to support compliance with PCI specification version 2.1. Settings: *Enabled* and *Disabled*.

PCI #2 Access #1 Retry

When *Disabled*, PCI#2 will not be disconnected until access finishes. When *Enabled*, PCI#2 will be disconnected if max retries are attempted without success.

AGP Master 1 WS Write

When *Enabled*, writes to the AGP bus are executed with one wait state inserted.

AGP Master 1 WS Read

When *Enabled*, one wait state is inserted in the AGP read cycle.

Memory Parity/ECC Check

User can set the field to *Enabled* for memory checking if the type of DRAM installed in your system is Parity or ECC (Error-Correcting Code) DRAM.

Integrated Peripherals

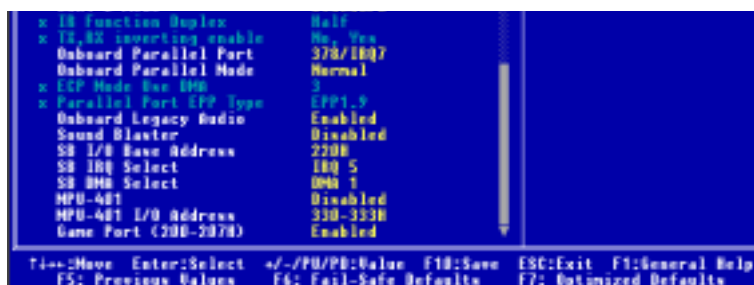
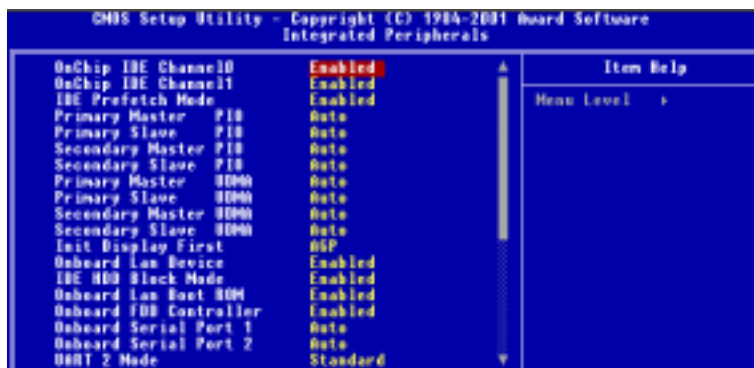

OnChip IDE Channel0/1

The integrated peripheral controller contains an IDE interface with support for two IDE channels. Choose *Enabled* to activate each channel separately.

IDE Prefetch Mode

The onboard IDE drive interfaces supports prefetching, for faster drive accesses. Set to *Disabled* if your primary and/or secondary add-in IDE interface does not support prefetching.

Primary/Secondary Master/Slave PIO

The four fields allow you to set a PIO (Programmed Input/Output) mode for each of the four IDE devices that the onboard IDE interface supports. Modes 0~4 provide increased performance. In Auto mode, BIOS automati-

Chapter 3

cally determines the best mode for each IDE device.

Primary/Secondary Master/Slave UDMA

Ultra DMA implementation is possible only if your IDE device supports it and your operating environment contains a DMA driver. If both your hard drive and software support Ultra DMA, select *Auto* to enable BIOS support.

Init Display First

This item specifies which VGA card is your primary graphics adapter. Available options: *PCI Slot* and *AGP*.

Onboard Lan Device

This is used to enable or disable the onboard LAN controller. Settings: *Enabled* and *Disabled*.

IDE HDD Block Mode

This allows your hard disk controller to use the fast block mode to transfer data to and from the hard disk drive. Block mode is also called block transfer, multiple commands or multiple sector read/write. *Enabled* enables IDE controller to use block mode; *Disabled* allows the controller to use standard mode.

Onboard Lan Boot ROM

Boot ROM of the LAN controller enables network booting or software installation/updating from a remote location. The field decides whether to invoke the boot ROM of the onboard LAN controller. Settings: *Enabled* and *Disabled*.

Onboard FDD Controller

This is to enable or disable the onboard Floppy controller. Set to *Enabled* if you have a floppy disk drive installed on the mainboard and want to use it.

Onboard Serial Port 1/2

These items specify the base I/O port address and IRQ for the onboard Serial Port 1 (COM 1)/Serial Port 2 (COM 2). Selecting to *Auto* allows BIOS to automatically determine the correct base I/O port address. Available options: *Auto*, *3F8/IRQ4*, *2F8/IRQ3*, *3E8/IRQ4*, *2E8/IRQ3* and *Disabled*.

Default is *Auto*. If you have ISA add-on card, the suggested configuration is as the following:

If the ISA add-on card has				Onboard Serial port to be set at			
COM1 (I/O:3F8H)	COM2 (I/O:3F8H)	COM3 (I/O:3E8H)	COM4 (I/O:2E8H)	PORT1	IRQ ASSIGNED	PORT2	IRQ ASSIGNED
✓	✓	✓	✓	DISABLED	X	DISABLED	X
✓	✓	X	X	COM3	4	COM4	3
X	X	✓	✓	COM1	4	COM2	3
✓	X	X	✓	COM2	3	COM3	4
X	✓	✓	X	COM1	4	COM4	3
✓	✓	✓	X	COM4	3	DISABLED	X
✓	✓	X	✓	COM3	4	DISABLED	X
✓	X	✓	✓	COM2	3	DISABLED	X
X	✓	✓	✓	COM1	4	DISABLED	X
X	X	X	X	COM1	4	COM2	3
✓	X	X	X	COM2	3	COM3	4
X	✓	X	X	COM1	4	COM3	4
X	X	✓	X	COM1	4	COM2	3
X	X	X	✓	COM1	4	COM2	3

UART2Mode

The item allows you to specify the operation mode for serial port “COM 2”. Settings are:

- Standard* RS-232C Serial Port
- HPSIR* IrDA-compliant Serial Infrared Port
- ASKIR* Amplitude Shift Keyed Infrared Port

IR Function Duplex

This field specifies a duplex value for the IR device connected to COM 2. Full-Duplex mode permits simultaneous two-direction transmission. Half-Duplex mode permits transmission in one direction only at a time. Settings: *Half* and *Full*.

Chapter 3

TX, RX inverting enable

This item allows you to enable the TX, RX inverting which depends on different H/W requirement. This field is not recommended to change its default setting for avoiding any error in your system. Settings are “No, Yes”, “Yes, No”, “Yes, Yes” and “No, No.”

Onboard Parallel Port

This specifies the base I/O port address and IRQ of the onboard Parallel Port. Settings: *378/IRQ7*, *278/IRQ5*, *3BC/IRQ7* and *Disabled*. If you have an ISA add-on card, the suggested configuration is as below:

If the ISA add-on card has			Onboard parallel port to be set as	
LPT1 I/O:378H	LPT2 I/O:278H	LPT3 I/O:3BCH	PORT ASSIGNED	IRQ ASSIGNED
✓	✓	✓	Disabled	X
✓	✓	X	LPT3	5
✓	X	✓	LPT2	5
X	✓	✓	LPT1	7
✓	X	X	LPT2	5
X	✓	X	LPT1	7
X	X	✓	LPT1	7
X	X	X	LPT1	7



Note: If the onboard parallel port interrupt and ISA add-on card interrupt are in conflict, the parallel port will not work properly. Please disable one of the devices.

Onboard Parallel Mode

This item selects the operating mode for the parallel port: *Normal*, *EPP*, *ECP* or *ECP/EPP*.

ECP Mode Use DMA

This item specifies an DMA channel 1 or 3 for the Parallel Port when it is set to *ECP* or *ECP/EPP* mode.

Parallel Port EPP Type

The item selects the EPP version used by the parallel port if the port is set to *EPP* or *ECP/EPP* mode. Settings: *EPP1.7* and *EPP1.9*.

Onboard Legacy Audio

The item enables or disables the onboard audio features of the mainboard and the following audio options in the BIOS.

Sound Blaster

The item turns on/off the Sound Blaster feature of the board. If you want to play the Sound Blaster compatible games, you need to set the field to *Enabled*.

SB I/O Base Address

This item specifies the I/O Base Address for the Sound Blaster. Settings are 220H, 240H, 260H and 280H.

SB IRQ Select

This item specifies the IRQ for the Sound Blaster. Settings: *IRQ 5*, *IRQ 7*, *IRQ 9* and *IRQ 10*.

SB DMA Select

This item specifies the DMA channel for the Sound Blaster. Settings: *DMA 1*, *DMA 2*, *DMA 3* and *DMA 0*.

MPU-401

The field enables or disables the MPU-401 interface (the Yamaha Sound Blaster mode).

MPU-401 I/O Address

This item selects the base I/O port address for the MPU-401 interface. Settings: *330-333H*, *300-303* and *310-313*.

Game Port (200-207H)

The item enables or disables the Joystick/Game port.

Chapter 3

Power Management Setup

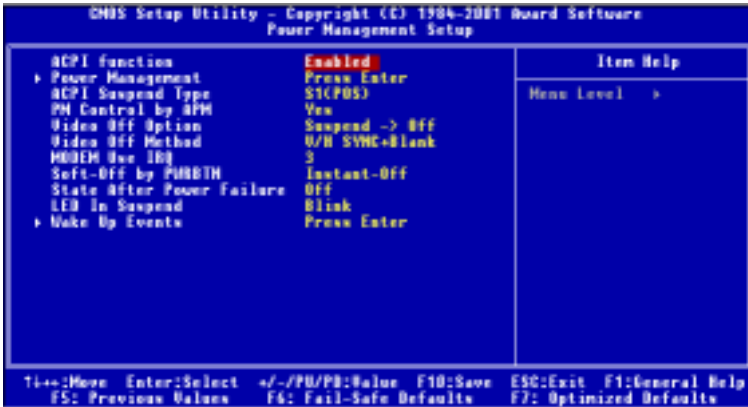

ACPI function

This item is to activate the ACPI (Advanced Configuration and Power Management Interface) Function. If your operating system is ACPI-aware, such as Windows 98SE/2000/ME, select *Enabled*. Settings: *Enabled* and *Disabled*.

Power Management

Press <Enter> to enter the sub-menu for power management options.

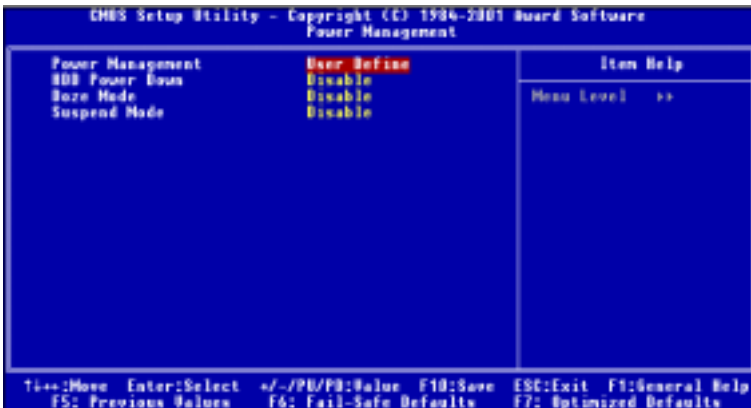

Power Management

This item is used to select the degree (or type) or power saving and is related to these modes: Doze Mode and Suspend Mode. There are three options for power management:

- Min Saving* Minimum Power Management. Doze Mode = 1 Hour, Suspend Mode = 1 Hour.
- Max Saving* Maximum Power Management. Doze Mode = 10 Sec, Suspend Mode = 10 Sec.
- User Define* Allows end users to configure each mode separately. Each of the ranges are from *1 Min* to *1 Hour*.

HDD Power Down

If HDD activity is not detected in the length of time specified in this field, the hard disk drive will be powered down while all other devices remain active. Settings: *Disable* and *1* through *15 Min*.

Doze Mode

After the selected period of system inactivity, the CPU clock will run at slower speed while other devices still run at full speed. Settings: *Disable, 1 Min, 2 Min, 4 Min, 6 Min, 8 Min, 10 Min, 20 Min, 30 Min, 40 Min* and *1 Hour*.

Suspend Mode

If system activity is not detected for the length of time specified in this field, all devices except CPU will be shut off. Settings: *Disable, 1 Min, 2 Min, 4 Min, 6 Min, 8 Min, 10 Min, 20 Min, 30 Min, 40 Min* and *1 Hour*.

ACPI Suspend Type

This item specifies the power saving modes for ACPI function. If your operating system supports ACPI, such as Windows 98SE, Windows ME and Windows 2000, you can choose to enter the Standby mode in S1(POS) or S3 (STR) fashion through the setting of this field. Options are:

- S1(POS)* The S1 sleep mode is a low power state. In this state, no system context is lost (CPU or chipset) and hard-

Chapter 3

S3(STR) ware maintains all system context.
The S3 sleep mode is a power-down state in which power is supplied only to essential components such as main memory and wake-capable devices, and all system context is saved to main memory. The information stored in main memory will be used to restore PC to previous state when an “wake up” event occurs.

PM Control by APM

Setting to *Yes* will activate an Advanced Power Management (APM) device to enhance Max Saving mode and stop CPU internal clock. Settings: *Yes* and *No*.

Video Off Option

The settings are *Always On*, *Suspend* and *All Modes*. This option is for choosing the setting in which the monitor will turn off.

Always On Always turn on.
Suspend --> Off During Suspend mode, the monitor will be turned off.
All Modes --> Off The monitor is turned off during Doze, Standby or Suspend mode.

Video Off Method

This determines the manner in which the monitor is blanked.

V/H SYNC+Blank This selection will cause the system to turn off the vertical and horizontal synchronization ports and write blanks to the video buffer.
Blank Screen This option only writes blanks to the video buffer.
DPMS Support Initial display power management signaling.

MODEMUseIRQ

Name the interrupt request (IRQ) line assigned to the modem (if any) on your system. Activity of the selected IRQ always awakens the system. Settings: *3, 4, 5, 7, 9, 10, 11* and *NA*.

Soft-Off by PWRBTN

This feature allows users to configure the power button as a normal power-on/-off button or a soft-off button. Settings are:

- Instant-Off* The power button functions as a normal power-on/-off button.
- Delay 4 Sec.* When you press the power button, the computer enters the suspend/sleep mode, but if the button is pressed for more than four seconds, the computer is turned off.

State After Power Failure

This item specifies whether your system will reboot after a power failure or interrupts occurred. Available settings are:

- Off* Leaves the computer in the power off state.
- On* Reboots the computer.
- Auto* BIOS automatically determines the best mode.

LED In Suspend

This item sets how the system uses Power LED on the case to indicate the suspend/sleep state. Settings are:

- Blink* The Power LED blinks to indicate the suspend state.
- Single* The Power LED remains the same color.
- Dual* The Power LED changes its color to indicate the suspend state.

Wake Up Events

Press <Enter> to enter the sub-menu and the following screen appears:

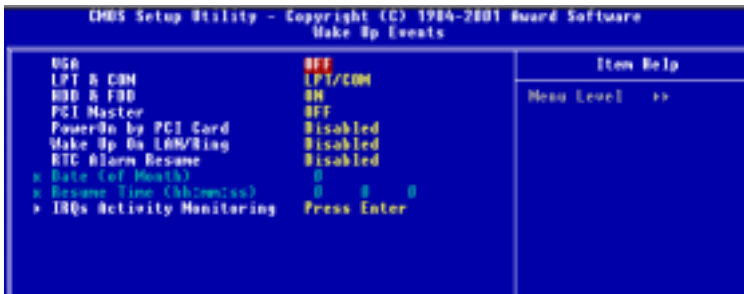

Chapter 3

VGA, LPT & COM, HDD & FDD, PCI Master, Power On by PCI Card, Wake Up On LAN/Ring

These items specify whether the system will be awakened from power saving modes when activity or input signal of the specified hardware peripheral or component is detected.

 **Note:** To use the function of “Wake Up On LAN/Ring”, you need to install a modem/LAN card supporting power on function.

RTC Alarm Resume

This is to enable or disable the feature of booting up the system on a scheduled time/date. Settings: *Enabled* and *Disabled*.

Date (of Month)

Specifies the date for **RTC Alarm Resume**. Settings are 0~31.

Resume Time (hh:mm:ss)

Specifies the time for **RTC Alarm Resume**. Format is <hour><minute><second>.

IRQs Activity Monitoring

Press <Enter> to enter the sub-menu and the following screen appears:

```
CMOS Setup Utility - Copyright (C) 1984-2001 Award Software
IRQs Activity Monitoring

Primary INT#          [RH]
IRQ0 (COM 2)         Enabled
IRQ4 (COM 1)         Enabled
IRQ5 (LPT 2)         Enabled
IRQ6 (Floppy Disk)   Enabled
IRQ7 (LPT 1)         Enabled
IRQ8 (RTC Alarm)     Disabled
IRQ9 (IRQ2 Redir)    Disabled
IRQ10 (Reserved)     Disabled
IRQ11 (Reserved)     Disabled
IRQ12 (PS/2 Mouse)   Enabled
IRQ13 (Coprocesor)   Enabled
IRQ14 (Hard Disk)    Enabled
IRQ15 (Reserved)     Disabled

Item Help
Menu Level >>>

F1--> Move  Enter:Select  +/-/PG/PD:Value  F10:Save  ESC:Exit  F1:General Help
F5: Previous Values  F6: Fail-Safe Defaults  F7: Optimized Defaults
```

Primary INTR

When this is set to *ON*, any event occurring will wake up the system which has been powered down.

IRQ3~IRQ15

Enables or disables the monitoring of the specified IRQ line. If set to *Enabled*, the activity of the specified IRQ line will prevent the system from entering power saving modes or awaken it from power saving modes.



***Note:** IRQ (Interrupt Request) lines are system resources allocated to I/O devices. When an I/O device needs to gain attention of the operating system, it signals this by causing an IRQ to occur. After receiving the signal, when the operating system is ready, the system will interrupt itself and perform the service required by the I/O device.*

Chapter 3

PnP/PCI Configurations



PNP OS Installed

When set to *YES*, BIOS will only initialize the PnP cards used for booting (VGA, IDE, SCSI). The rest of the cards will be initialized by the PnP operating system like Windows® 95 or 98. When set to *NO*, BIOS will initialize all the PnP cards. So, select *Yes* if the operating system is Plug & Play aware.

Reset Configuration Data

The ESCD (Extended System Configuration Data) is a method that the BIOS uses to store resource information for both PnP and non PnP devices in a bit string format. When *Enabled*, the system will rebuild ESCD and you will see the message “ESCD Update Successfully” on boot up.

Resources Controlled By

If select *Auto(ESCD)*, BIOS will automatically configure all the boot and PnP (Plug & Play) compatible devices and assigns system resources like IRQ to these devices. However, this feature means absolutely nothing unless you are using a Plug and Play operating system such as Windows®95/98. If you want to configure by yourself, select *Manual*.

IRQ/DMA Resources

The items are adjustable only when **Resources Controlled By** is set to

Manual. Press <Enter> and you will enter the sub-menu of the items. **IRQ Resources & DMA Resources** list IRQ-3/-4/-5/-7/-9/-10/-11/-12/-14/-15 and DMA-0/-1/-3/-5/-6/-7 for users to set each IRQ/DMA a type depending on the type of device using the IRQ/DMA. Settings are:

PCI/ISA PnP For Plug & Play compatible devices designed for PCI or ISA bus architecture.

Legacy ISA For devices compliant with the PC AT bus specification, requiring a specific interrupt.

PCI/VGA Palette Snoop

PCI VGA palette is the set of colors currently used by the video device. Some special VGA cards may not show colors correctly and need to look into the video device's VGA palette to determine what colors are in use. Then you have to turn on the palette "snoop", permitting the palette registers of both VGA devices to be identical. The setting must be set to Enabled if any non-standard VGA adapter card, such as MPEG card, installed in the system requires VGA palette snooping.

Assign IRQ For VGA/USB

Set to *Enabled* allows BIOS to assign an IRQ to VGA card/USB device. Choose *Disabled* if you want to release the IRQ.

Chapter 3

PC Health Status

This section is to monitor the current hardware status including CPU temperature, CPU Fan speed, Vcore etc. This is available only if there is hardware monitoring onboard.

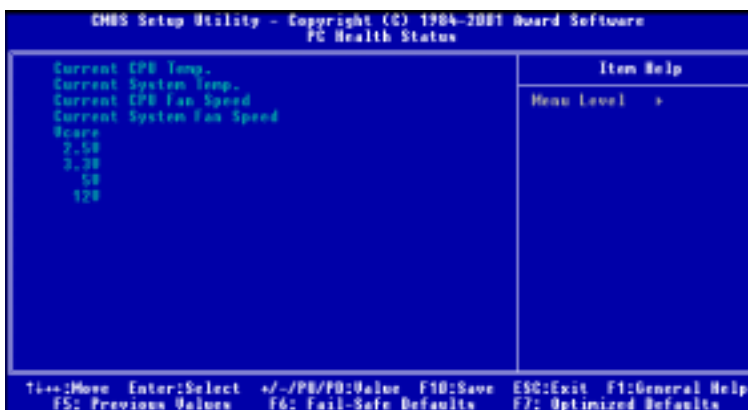

Current CPU Temp., Current System Temp., Current CPU/System Fan Speed, Vcore, 2.5/3.3/5/12V

These items display the current status of all of the monitored hardware devices/components such as CPU voltages, temperatures and all fans's speed.

Frequency/Voltage Control

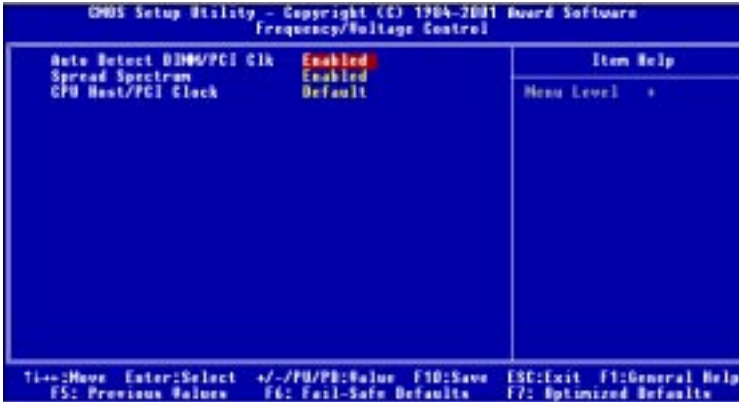

Auto Detect DIMM/PCI Clk

This item is used to auto detect the DIMM/PCI slots. When set to *Enabled*, the system will remove (turn off) clocks from empty DIMM/PCI slots to minimize the electromagnetic interference (EMI). Settings: *Enabled* and *Disabled*.

Spread Spectrum

When the motherboard clock generator pulses, the extreme values (spikes) of the pulses creates EMI (Electromagnetic Interference). The Spread Spectrum function reduces the EMI generated by modulating the pulses so that the spikes of the pulses are reduced to flatter curves. If you do not have any EMI problem, leave the setting at *Disabled* for optimal system stability and performance. But if you are plagued by EMI, setting to *Enabled* for EMI reduction. Remember to disable Spread Spectrum if you are overclocking because even a 0.25% jitter can introduce a temporary boost in clockspeed of 25MHz (with a 1GHz CPU) which may just cause your overclocked processor to lock up.

CPU Host/PCI Clock

This item specifies the combination of CPU host bus (FSB) and PCI bus frequency and provides a method for end users to overclock the processor accordingly. If the item shows *Default*, the clock frequency will use the default value for both the CPU host bus and PCI bus.

Chapter 3

Load Fail-Safe/Optimized Defaults

The two options on the main menu allow users to restore all of the BIOS settings to the default Fail-Safe or Optimized values. The Optimized Defaults are the default values set by the mainboard manufacturer specifically for the optimal performance of the mainboard. The Fail-Safe Defaults are the default values set by the BIOS vendor for the stable system performance.

When you select Load Fail-Safe Defaults, a message as below appears:



Pressing Y loads the BIOS default values for the most stable, minimal system performance.

When you select Load Optimized Defaults, a message as below appears:



Pressing Y loads the default factory settings for optimal system performance.

Chapter 3

Set Supervisor/User Password

When you select this function, a message as below will appear on the screen:



Type the password, up to eight characters in length, and press <Enter>. The password typed now will clear any previously set password from CMOS memory. You will be prompted to confirm the password. Re-type the password and press <Enter>. You may also press <Esc> to abort the selection and not enter a password.

To clear a set password, just press <Enter> when you are prompted to enter the password. A message will show up confirming the password will be disabled. Once the password is disabled, the system will boot and you can enter Setup without entering any password.

When a password has been set, you will be prompted to enter it every time you try to enter Setup. This prevents an unauthorized person from changing any part of your system configuration.

Additionally, when a password is enabled, you can also have BIOS to request a password each time the system is booted. This would prevent unauthorized use of your computer. The setting to determine when the password prompt is required is the Security Option of the Advanced BIOS Features menu. If the Security Option is set to *System*, the password is required both at boot and at entry to Setup. If set to *Setup*, password prompt only occurs when trying to

enter Setup.



About Supervisor Password & User Password:

Supervisor password :

Can enter and change the settings of the setup menu.

User password:

Can only enter but do not have the right to change the settings of the setup menu.

Chapter 3

Save & Exit Setup

When you want to quit the Setup menu, you can select this option to save the changes and quit. A message as below will appear on the screen:

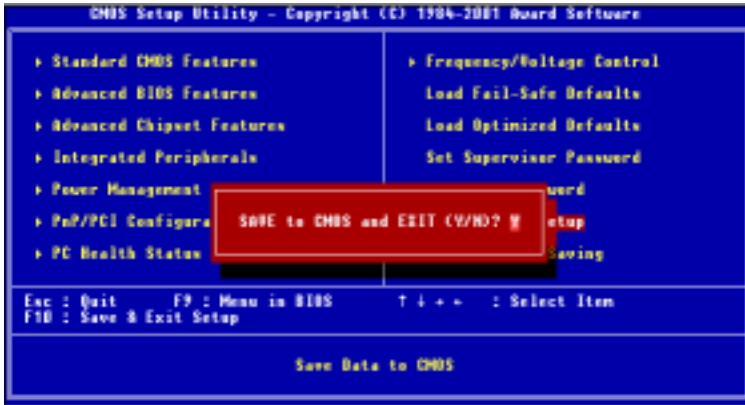

Typing *Y* will allow you to quit the Setup Utility and save the user setup changes to RTC CMOS.

Typing *N* will return to the Setup Utility.

Exit Without Saving

When you want to quit the Setup menu, you can select this option to abandon the changes. A message as below will appear on the screen:



Typing *Y* will allow you to quit the Setup Utility without saving any changes to RTCMOS.

Typing *N* will return to the Setup Utility.

Installing Drivers

4

The chapter describes how to install drivers for VIA chipset, AC97 audio, VGA and Realtek® 8100 fast ethernet controller, and the basic system requirements for driver installation. To install the drivers correctly, you must **install VIA chipset driver prior to other drivers.**

This chapter includes the following topics:

VIA Driver Installation for Windows® 98SE/ 2000/ME/NT4.0	4-2
Realtek® 8100 Fast Ethernet Controller	4-4

Chapter 4

VIA Driver Installation for Windows® 98SE/2000/ME/NT4.0

 **Note 1:** Install Windows® 2000 Service Pack2 or the latest version before installing the VIA drivers into Windows® 2000.

Note 2: Install Windows® NT4.0 Service Pack 6 or above before installing the VIA drivers into Windows® NT.

Installing VIA® Chipset Driver

1. Insert the supplied CD disk into the CD-ROM drive.
2. The CD will auto-run and the setup screen will appear.
3. Click on **Via Chipset Drivers** and follow the on-screen instructions to complete the installation.
4. Restart the system for the new chipset driver.

Installing VIA® AC97 PCI Sound Driver

1. Make sure the supplied CD disk is in the CD-ROM drive.
2. Go to **My Computer** and double click the CD-ROM icon. The setup screen will appear again.
3. Click on **VIA AC97 PCI Sound Drivers** and follow the on-screen instructions to complete the installation.
4. Restart the system.

Installing VIA® PLE133 VGA Driver

1. Make sure the supplied CD disk is in the CD-ROM drive.
2. Go to **My Computer** and double click the CD-ROM icon. The setup screen will appear again.
3. Click on **VIA PLE/KLE133 VGA Driver** and follow the on-screen instructions to complete the installation.
4. Restart the system.



One Touch Setup:

*In Windows 2000/ME, you may see the **One Touch Setup** button appear on the setup screen. Choosing the button will help you to install more than one driver into the system without going through the installation process step by step and save a lot of time accordingly. After clicking on One Touch Setup, a window will show up indicating what drivers will be installed. Install other drivers not included by One Touch Setup manually if any.*

Chapter 4

Realtek® 8100L Fast Ethernet Controller

When your mainboard comes with the Realtek® 8100L LAN controller, you must install the Realtek® LAN driver to support the LAN function. The Realtek® 8100L is a sophisticated 32-bit PCI component, with enhanced scatter-gather bus mastering capabilities. Its true 32-bit architecture enables it to perform high speed data transfers on the PCI bus using four DMA channels.

Features

- IEEE 802.3/802.3u 10BASE-T and 100BASE-TX compatible
- Glueless 32-bit PCI bus master interface
- Backward software compatible to the 82557
- Internal transmit and receive FIFOs (3 kbytes each)
- Back-to-back transmit at 100 Mbps within minimum IFS
- EEPROM support for configuration and customized feature selection
- Advanced configuration and Power Interface Specification, Revision 1.0, and PCI Power Management Specification, Revision 1.0 compliant
- Remote Wake Up (Magic Packet*) support in APM and ACPI modes
- ACPI “interesting” packet wake support in D0 to D3 low power states
- IEEE 802.3u Auto-Negotiation support for 10BASE-T and 100BASE-TX
- Full or half duplex capable at 10 or 100 Mbps
- IEEE 802.3x flow control support

Driver Installation

Installation for Windows® 98/2000/ME

In some operating systems like Windows® 98/2000/ME, the provided CD will auto-run when you insert the CD disk into the CD-ROM drive. To install the LAN driver, just click on the “**Realtek Network Drivers**” button on the screen.

Installation for Windows® NT4.0

1. Insert the supplied CD disk into the CD-ROM drive.
2. Copy all files under *CD-ROM drive:\Network\Realtek\8139\Winnt4* to your hard disk. For example, copy the files to *C:\Lan*.
3. Right click on **Network Neighborhood**.
4. Select **Properties**.
5. Click **Yes** to install the driver.
6. Click **Next**.
7. Choose **Select from list**.
8. Click **Have Disk** to specify the path of Lan driver.
9. Type the path where the Lan driver exists. In the above example, it should be *C:\Lan*. Then click **OK**.
10. When the driver is found, click **OK**.
11. Follow the on-screen instructions and continue to click **OK** or **Next**.
12. When the **Windows NT Setup** window appears, insert the Windows NT CD disk into CD-ROM drive and type the path to CD-ROM drive. Then click **OK** to start copying Windows NT files into the system.
13. Follow the on-screen instructions to complete installation.
14. Restart your system.

Installation for Other O/S

To find out the installation procedures for other operating systems such as Linux, insert the provided CD disk into the CD-ROM drive. Run or type the path to:

CD-ROM drive:\Network\Realtek\8139\Help8139.exe

Then press spacebar to continue and installation of the LAN driver for different operating systems is listed on the screen. Select the operating system you need by using arrow keys and follow the installation procedures provided.